



# Installer & User Manual

## NexBlue Point (UK)





# Table of contents

English

<b>Initial</b> look at NexBlue Point (UK)	5
<b>Features</b> of NexBlue Point (UK)	6
<b>Safety</b> instructions	7
<b>Installation</b> guide	9
<b>Status</b> light indicator	11
<b>Apps</b> and warranty	12
<b>Declaration</b> of conformity	12
<b>Technical</b> specifications	13

# Initial look at NexBlue Point (UK)

NexCore

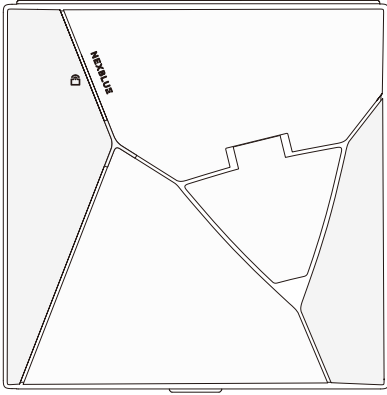

Backplate

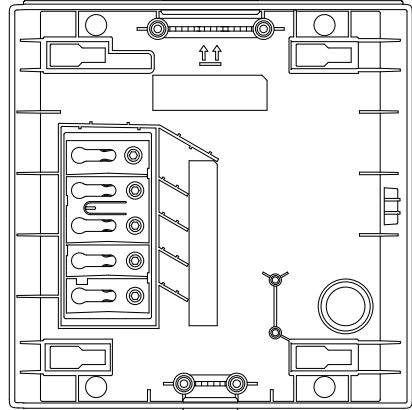

Φ 4×20 mm  
screws



×4

Φ 4×8 mm  
screws



×2

Φ 5×50 mm  
screws



×4

Φ 8×40 mm  
Anchors

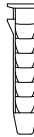

×4

Sealing plug

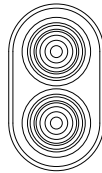

×1

Cable clamp

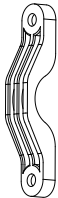

×1

Cable clamp

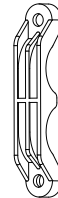

×1

Cable clamp

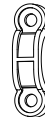

×2

NexBlue RFID card

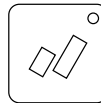

# Features of NexBlue Point (UK)

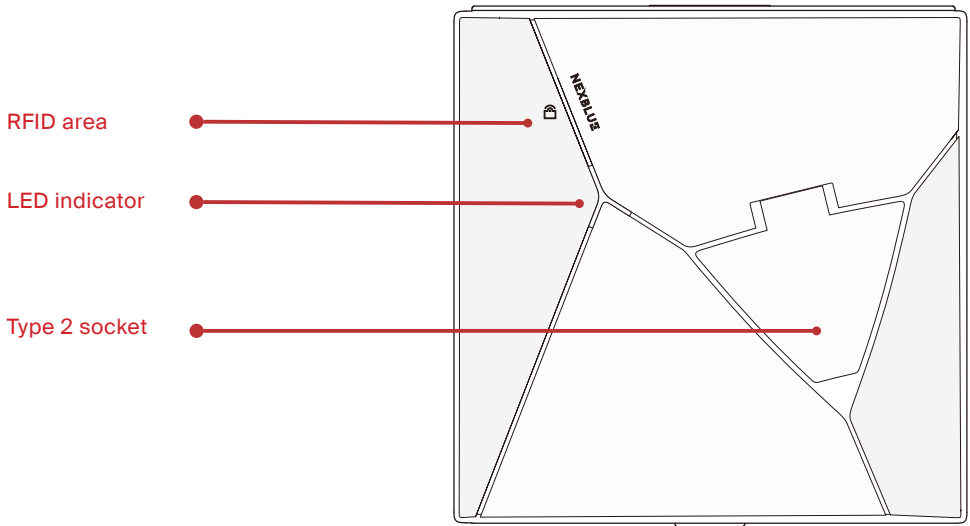

## RFID area

Access to the charger and identify users effortlessly with the built-in RFID reader. Control the charging process using the RFID card provided in the package or any other compliant RFID card of your choice. For additional details, refer to the myNexBlue App.

## LED indicator

Reflect the status of the charger. The significance of each color is available for reference on the "Status Light Indicator" page.

## Type 2 socket

The Type 2 socket is universally compatible and can charge any type of electric vehicle using the suitable charging cable. Moreover, you have the option to permanently lock the charging cable for added convenience.

# Safety instructions

**Notice!** Please read the safety instructions carefully before installing and operating the product. Pay special attention to the instructions marked with stars.

## Installation

- \*1. Ensure** that this product is properly connected to an upstream circuit breaker (MAX 40A, C-curve recommended) and an RCD suitable for the electrical connection and meeting the requirements of the applicable regulations (40A, 30mA type A RCD recommended). Please note that regulations may be different depending on your region or country of residence.
- \*2. Installation** of this product is restricted to certified electricians. Ensure compliance with national and regional regulations during the installation process.
- 3. Ensure** the AC grid connection and load planning for the charger aligns with the current national and regional laws, regulations, and standards. Review and obtain approval from the relevant authorities for compliance.
- 4. Before** and during installation, make sure to switch off the power and electricity. Activate the power only after the entire installation has been completed by a qualified electrician.
- 5. Ensure** products are stored away from inflammables, explosives, or flowing water. Avoid exposure to direct sunlight and extreme weather conditions, such as blizzards and thunderstorms.
- 6. Maintain** a relative humidity in the storage and usage space below 80%. Avoid the presence of radioactive or corrosive substances. Maintain a stable temperature within the range specified in the technical specifications. For outdoor facilities, conduct inspections in accordance with local laws and regulations.
- 7. Ensure** this product is safely installed in a fixed location with sufficient wall or structural load bearing capacity.
- 8. Avoid** installing this product in close proximity to strong electromagnetic fields or radio transmitters.
- 9. Follow** the installation guide for the open and close step of the installation to avoid damaging the NexBlue charger.
- 10. Avoid** using the charging cable with extension cables or adapters; use only cables specified in the IEC 62196. Do not step on or squeeze the cable during installation. To ensure safe and efficient charging, the electrician must verify that the cable and charger are compatible and free from any wear or damaged insulation. Position the cable in a way that prevents unintended

movement by humans, animals, or other moving objects.

- 11. The** electrician and purchaser are responsible for connecting and installing the ground protection. It is critical that the installation is correctly grounded and that a suitably grounded receptacle is used in accordance with local laws and regulations.
- 12. The** equipment is intended for non-restricted access.

## Operation

- \*1. Ensure** thorough reading of the safety instructions before using or servicing the charger. Failure to follow and apply all the instructions and procedures outlined in this quick guide will void the guarantee and result in NexBlue and its partners waiving all liability and claims for compensation.
- 2. Please** keep the PIN code in a safe place as you might need to use it in the future.
- 3. When** the power circuit is active, the terminals on the backplate are electrified and should never be touched or contacted, except during the standard slide-in installation of the charger by a qualified electrician.
- 4. The** optional function for ventilation is not supported by the charger (EN IEC 61851-1 6.3.2.2).
- 5. Designed** to comply with clause 722.411.4.1 of BS 7671:2018 A1 (British Standard), the charger incorporates a protection mechanism that completely disconnects the vehicle in the event

of detecting an indication of a broken PEN conductor.

- 6. Do** not use any conductor or foreign objects except cable plugs to touch the socket.
- 7. Users** should avoid forcefully pulling or poking the cable with sharp objects, and should refrain from touching the cable plug with wet hands.
- 8. Never** use extension cords, and promptly replace any damaged cables or plugs to prevent any potential safety hazards.
- 9. Do** not allow individuals (including children) with reduced physical, sensory, or mental capabilities, or those lacking experience and knowledge, to use electrical devices unsupervised.

## Maintenance

- \*1. Ensure** that repairs are performed by workshops approved by the manufacturer, and maintenance of the charger must adhere to national and regional laws, regulations, and standards.
- 2. Maintenance** for the charger should only be performed by authorized electricians. Ensure that power is disconnected before disassembly, and follow the reverse operations as per the instruction manual.
- 3. Transport** chargers in their packaging. In the event of a fall, conduct a visual inspection to avoid damage. Do not use damaged products.
- 4. Contact** NexBlue customer support to dispose the charger.



# Installation guide

**Notice!** The installation must be carried out by a qualified electrician only. When using and installing this product, please make sure to have the instruction manual at hand.

## 1. Opening

- **Pushing** the NexCore to the left to detach the charger.
- **Reminder** stickers are provided to assist in opening the NexCore in the correct direction.

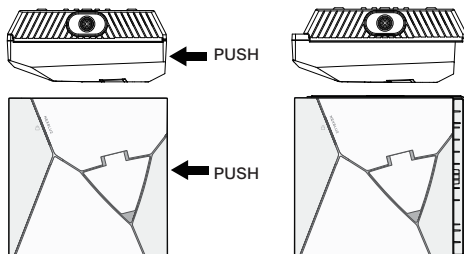

## 2. Preparing and Mounting

**Notice!** The product must be securely mounted on a vertical non-porous wall or structure that covers the entire back of the product and has sufficient load-bearing capacity.

- **Choose** one of the 3 cable entries as stated below and cut the sealing plug to fit the cable.
- **Seal** the rest cable entries with the other sealing plugs.

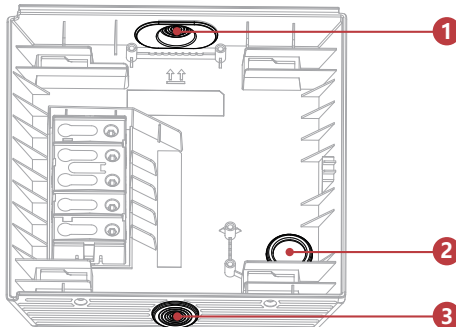

- **Determine** the installation height. (recommend 120-170 cm)
- **Fix** the backplate to a stable wall or surface with the provided 4 backplate screws and wall anchors.
- **Insert** the cable through the cut sealing plug.

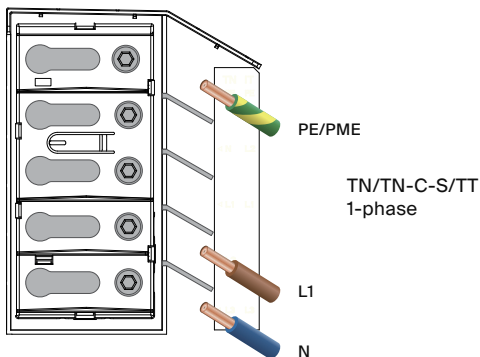
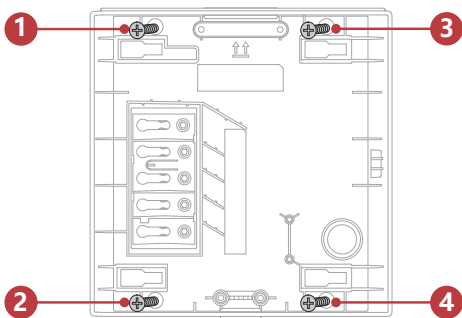

### 3. Wiring

#### Notice!

The cable colors may vary in accordance with national standards. The illustrations provided in this manual adhere to the IEC 60446 standard.

- **Strip** the cable cores by 12 mm and use ferrules on the wires if the cable has flexible conductors.
- **Insert** the cable and tighten the screws.
- **Tighten** the screws with a torque of 7 Nm.

#### 4. Sliding and fixing



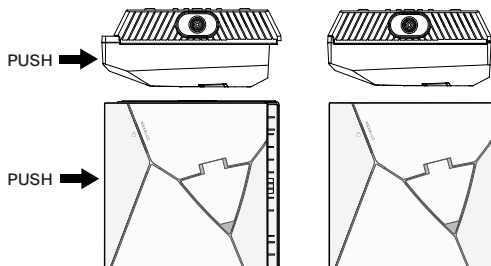

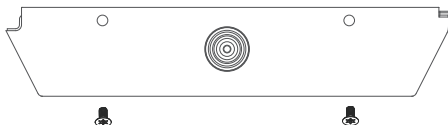

- **Make** sure the wires are properly connected before turning on the power.
- **Slide** the NexCore to the right (opposite direction shown in step 1). Ensure the NexCore and backplate are tightly closed all around without any gaps.



- **Tighten** two anti-theft screws at the bottom to secure the whole NexBlue charger. You may remove the reminder stickers after finishing the installation.

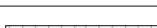

#### Status light indicator

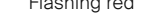
Light	Status
 Breathing orange	Not configured by electrician
 Constant orange	Disabled
 Constant blue	Ready to charge
 Breathing blue	Charging
 Constant white	Standby, online
 Breathing white	Standby, offline
 Flashing red	Critical error (such as PEN Fault). If the issue persists, contact NexBlue customer support and DO NOT attend to charge or touch the charger.
 Constant red	General error. Check the NexBlue App for further information.

# Apps and warranty

## Apps

The myNexBlue app and NexBlue Partner app are available on the App Store and Google Play.

### App for users

MyNexBlue



iOS APP Store

MyNexBlue



Google Play

### App for installers

NexBlue Partner



iOS APP Store

NexBlue Partner



Google Play

## Partner Portal

NexBlue Partner Portal : <https://partner.nexblue.com>

## Guide Videos

All guide videos for Users & Partners can be seen:

<https://nexblue.com/pages/product-tutorial>

## Warranty

We provide a 3-year limited warranty applicable to correctly installed the charger units. For more information, please see our website's warranty section.

## Declaration of conformity

The charger has been developed, produced, tested and supplied in accordance with the applicable legal regulations of the specified sales regions. The full text of the UK Declaration of Conformity and the UK Smart Charging Regulations Statement of Compliance are available on NexBlue website at: <https://nexblue.com/pages/document-and-manuals>

# Technical specifications

## General

<b>Model No.</b>	NB2670A
<b>Dimensions (mm)</b>	H: 235 × W: 230 × D: 130
<b>Wall Mounting (mm)</b>	H: 206 × W: 130
<b>Weight</b>	1.7 kg
<b>Operating Temperature</b>	-30 °C to +50 °C
<b>Storage Temperature</b>	-40 °C to +70 °C
<b>Usage Humidity</b>	5% to 80%
<b>Usage Altitude</b>	< 2000m
<b>External Package</b>	Carton
<b>Warranty</b>	3 years

## User Interface

<b>Enclosure</b>	Plastics
<b>LED Indicator</b>	Red / Green / Blue / White / Orange
<b>RFID Reader</b>	ISO / IEC 14443 Type A
<b>Start Mode</b>	myNexBlue APP / RFID / NFC / Plug & Play / NexBlue User Portal

## Connectivity

<b>Wi-Fi</b>	100mW 2.4 GHz 802.11b/g/n
<b>Bluetooth</b>	10mW BLE 4.2
<b>GSM</b>	2W at GSM900; 1W at DCS1800
<b>3G/4G</b>	126mW at B1, B3, B8, B20, B28
<b>Sub-1 GHz</b>	0.69mW at 868MHz
<b>OCPP</b>	Local OCPP 1.6-J

## Regulations

<b>LVD</b>	2014/35/EU
<b>EMC</b>	2014/30/EU
<b>RED</b>	2014/53/EU
<b>ROHS</b>	2011/65/EU
<b>Other</b>	The Electric Vehicles (Smart Charge Points) Regulations 2021

## Charging & Power grids

<b>Charging Mode</b>	Mode 3
<b>Charging Power</b>	1.4 to 7.4 kW
<b>Charge Connector</b>	Type 2 Socket
<b>Rated Current</b>	6 A to 32 A 1 phase
<b>Maximum Output Current</b>	32A
<b>Voltage</b>	230V AC ( $\pm 10\%$ )
<b>Installation Network</b>	TN-C-S, TN-C, TN-S and TT
<b>Mains Frequency</b>	50 Hz

## Protection

<b>Built-in Energy Meter</b>	$\pm 2\%$
<b>Built-in Residual Current Protection<sup>1</sup></b>	RDC-DD (6 mA DC) according to IEC 62955 <sup>2</sup>
<b>Upstream Circuit Breaker</b>	MAX 40A, C-curve recommended
<b>Ingress Protection</b>	IP54 (indoor and outdoor use)
<b>PEN Fault Protection</b>	Integrated protection according to BS 7671:2018/A2:2022
<b>Impact Protection</b>	IK08
<b>Insulation Class</b>	I
<b>Overvoltage Category</b>	III
<b>EMC Level</b>	CLASS B
<b>Other Protection</b>	Overload protection; Residual current protection; Surge protection; Over/Under voltage protection; Temperature protection; Relay welding protection; Anti-Tamper protection

1. Before each charge or at least 24 hours, the built-in Residual Current Device will automatically perform a selfcheck.

2. External multipole RCD Type A (30mA) is required.



www.nexblue.com

NexBlue AB  
Sven Rinmans Gata 6  
112 37 Stockholm  
Sweden

NexBlue UK Limited  
71-75, Shelton Street  
Covent Garden  
London  
WC2H 9JQ  
United Kingdom

Support@nexblue.com

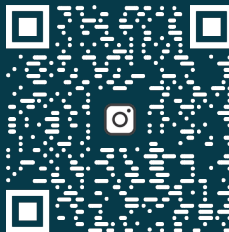

Instagram  
@nexblue.official

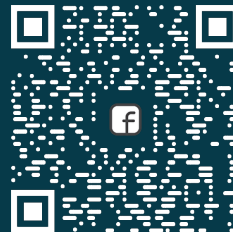

Facebook  
@NexBlueOfficial