

Ecoflow PowerOcean LFP Battery

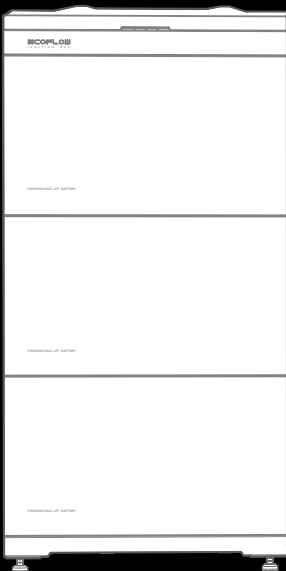

# CONTENTS

1	<b>Safety Instructions</b>	3	Battery Capacity Description	6	<b>System Maintenance</b>
1	Disclaimer	3	Networking Application	6	System Power-Off
1	Statement	4	Appearance	6	Routine Maintenance
1	Symbol Conventions	4	Label Description	6	Battery Storage and Recharge
1	General Requirements	5	Features	7	Replacing a fuse
1	Personnel Requirements	5	<b>System Modes</b>	7	<b>Used Batteries Disposal</b>
1	Electrical Safety	5	Self-Powered Mode	8	<b>Technical Parameters</b>
2	Battery Safety	6	<b>Checking before the Installation</b>		
2	Transportation Requirements		Checking Outer Packing		
2	Installation Environment Requirements	5	Checking Deliverables		
3	Equipment and Personnel Safety Requirements	5	<b>System Installation</b>		
3	<b>Product Introduction</b>	5	<b>Electrical Connection</b>		
3	Function	5	<b>System Commissioning</b>		
		5	System Power-on		

# Safety Instructions

## DISCLAIMER





Read this user manual carefully before using the product to ensure that you completely understand the product and can correctly use it. After reading this user manual, keep it properly for future reference. Improper use of this product may cause serious injury to yourself or others, or cause product damage and property loss. Once you use this product, it is deemed that you understand, approve and accept all the terms and content in this document. EcoFlow is not liable for any loss caused by the user's failure to use this product in compliance with this user manual. In compliance with laws and regulations, EcoFlow reserves the right to final interpretation of this document and all documents related to this product. This document is subject to changes (updates, revisions, or termination) without prior notice. Please visit EcoFlow's official website to obtain the latest product information.

## STATEMENT

This manual contains important safety and operating instructions. Before installation, operation, and maintaining the equipment, read this manual and observe all the safety instructions on the equipment and in this manual. Ensure that the equipment is used in environments that meet its design specifications. Otherwise, the equipment may become faulty, and the resulting equipment malfunction, component damage, personal injuries, or property damage are not covered under the warranty. Follow local laws and regulations when installing, operating, or maintaining the equipment. The safety instructions in this manual are only supplements to local laws and regulations. EcoFlow will not be liable for any consequence caused by the violation of general safety requirements or design, production, and usage safety standards.

## SYMBOL CONVENTIONS

This is a safety warning symbol. Such safety information alerts you to hazards that can be lethal to you and others, and that can cause damages to the equipment. All safety information is preceded by safety warning symbols and hazard words, including: "DANGER", "WARNING", "CAUTION", and "NOTICE". The "DANGER", "WARNING", "CAUTION", and "NOTICE" statements in this manual do not cover all the safety instructions. They are only supplements to the safety instructions.

Symbol	Description
	Indicates a hazard with a high level of risk which, if not avoided, will result in death or serious injury.
	Indicates a hazard with a medium level of risk which, if not avoided, could result in death or serious injury.
	Indicates a hazard with a low level of risk which, if not avoided, could result in minor or moderate injury.
	Indicates a potentially hazardous situation which, if not avoided, could result in equipment damage, data loss, performance deterioration, or unanticipated results. NOTICE is used to address practices not related to personal injury.

## GENERAL REQUIREMENTS

### DANGER

- Do not work with power on during installation.
- If the power cord of this equipment is damaged, it must be replaced by the manufacturer, customer service department or qualified personnel to prevent a safety hazard.
  - Do not touch the exposed cable with your hands.
  - Make sure the cables, connectors and ports are dry before starting up the equipment. Make sure all three are connected securely.
  - Do not install, use, or operate outdoor equipment and cables in harsh weather

- conditions such as lightning, rain, snow, and level 6 or stronger wind.
- Tighten the screws to the specified torque using tools when installing the equipment.
- After installing the equipment, remove the remnants of the device installation area, such as cardboard boxes, foam, plastic, wire ties, stripped insulation materials, etc.
- All warning label and nameplates on the equipment should be visible after installation is complete. Do not scrawl, damage, or block any warning label on the device.
- Understand the components and functioning of a grid-tied PV power system and relevant local standards.
- If there is any paint scratches caused during equipment transportation or installation, do not continue to put the equipment into use, contact the customer service department to deal with it in a timely manner. Equipment with scratches cannot be exposed to an outdoor environment for a long period of time in case of the waterproof performance of the equipment from decreasing or rusting.
- Do not open the host panel of the equipment without permission.
- Do not reverse engineer, decompile, disassemble, adapt, add code to the device software or alter the device software in any other way. Any other operation that violates the original design specifications of the device hardware and software is not allowed.
- If there is a probability of personal injury or equipment damage during operations on the equipment, immediately stop the operations, take feasible protective measures.
- Use tools correctly to avoid hurting people or damaging the equipment.
- Do not touch the energized equipment, as the enclosure is hot.
- Use insulated tools when operating equipment and wear personal protective equipment to ensure personal safety. Wear anti-static gloves, clothing and wristbands when touching electronic devices to protect equipment from damage.

## PERSONNEL REQUIREMENTS

- Personnel who plan to install or maintain EcoFlow equipment must receive thorough training, understand all necessary safety precautions, and be able to correctly perform all operations.
- Only qualified professionals are allowed to install, operate, and maintain the equipment.
- Personnel who will operate the equipment, including operators, trained personnel, and professionals, should possess the local national required qualifications in special operations such as high-voltage operations, working at heights, and operations of special equipment.



Professionals: personnel who are trained or experienced in equipment operations and are clear of the sources and degree of various potential hazards in equipment installation, operation, and maintenance.

## ELECTRICAL SAFETY

### GROUNDING

- For the equipment that needs to be grounded, install the ground cable first when installing the equipment and remove the ground cable last when removing the equipment.
- Do not damage the ground conductor.
- Do not operate the equipment in the absence of a properly installed ground conductor.
- Ensure that the equipment is connected permanently to the protective ground. Before operating the equipment, check its electrical connection to ensure that it is securely grounded.

### GENERAL REQUIREMENTS

#### DANGER

- Before connecting cables, ensure that the equipment is intact. Otherwise, electric shocks or fire may occur.
- Ensure that all electrical connections comply with local electrical standards.
  - Obtain approval from the local electric utility company before using the equipment in grid-tied mode.
  - Ensure that the cables installer prepared meet local regulations.
  - Use dedicated insulated tools when performing high-voltage operations.
  - Before connecting a power cable, check that the label on the power cable is correct. When fabricating cables and installing connectors on site, follow the respective instructions in this manual and the requirements of local laws and regulations.
  - Before operating the equipment, disconnect all power to the equipment and wait for the corresponding delayed discharge time to ensure that the equipment is completely de-energized.

### CABLING

- The cabling path must avoid the equipment cooling system and parts.
- When routing cables, ensure that a distance of at least 30 mm exists between the cables and heat-generating components or areas. This prevents damage to the insulation layer of the cables.
- Bind cables of the same type together. When routing cables of different

types, ensure that they are at least 30 mm away from each other. Mutual entanglement or cross-deployment is not allowed.

4. Ensure that the cables used in a grid-tied PV power system are properly connected and insulated and meet specifications.

## BATTERY SAFETY

1. After system installing and connecting electrical, power on the battery system in a timely manner to avoid capacity loss or irreversible damage to the batteries.
2. Correctly set the battery operation management parameters.
3. The customer or a third party is not allowed to use the batteries beyond the scenarios specified by the Company: such as connecting extra loads to the battery, or using with other batteries, including but not limited to batteries of other brands, or batteries of different rated capacities, etc.
4. Battery operating environment or external power parameters **MUST** meet environment requirements: such as the actual operating temperature of the battery meets the specifications; the power grid is stable, etc.) to avoid damage to the battery.
5. Batteries shall not be frequently over-discharged.
6. Batteries shall be correctly expanded (maximum 45.9 kWh).
7. Batteries shall not fully charged for a long time.
8. Maintain batteries based on the this manual, such as check battery terminals regularly.
9. Do not use batteries that have exceeded the warranty period.
10. Capacitive discharge: can be reduced to safety voltage within 10 seconds.

## BASIC REQUIREMENTS

### DANGER

- Do not expose batteries at high temperatures or around heat-generating sources. The battery may cause a fire if overheated.
- Do not disassemble, alter, or damage batteries. For example, do not insert foreign objects into batteries or place batteries in water or other liquids.
- The fire hazard of the battery energy storage system is high. Consider the following safety risks before handling batteries:
  - Battery electrolyte is combustible, toxic, and volatile.
  - Battery thermal runaway can generate flammable gas and harmful gas such as CO and HF.
  - The concentration of flammable gas generated from battery thermal runaway may cause deflagration and explosion.
- Obvious battery abnormalities, such as electrolyte leakage and structural deformation, indicate potential safety risks. Contact your installer or professional personnel to remove and replace the battery.
- The batteries must be stored separately inside the packaging. Do not store batteries together with other materials or in the open air. Do not stack batteries too high (Allows stacking of up to three packs).
- Do not remove the battery packaging before use.
- Move batteries in the correct direction. Do not place a battery upside down or tilt it.
- Protect batteries from impact.
- Do not perform welding or grinding work around batteries to prevent fire caused by electric sparks or arcs.
- Use batteries within the temperature range specified in this manual.
- Do not use damaged batteries (such as damage caused when a battery is dropped, bumped, or dented on the enclosure). Damaged batteries may release flammable gases. Do not store damaged batteries near undamaged products.
- Do not place damaged batteries in close proximity to flammable materials. Do not approach the damaged batteries unless you are a professional.
- Monitor damaged batteries during storage for signs of smoke, flame, electrolyte leakage, or heat.
- Do not place irrelevant objects on the top of the equipment or insert them into any position of the equipment.
- Remove any metal objects from yourself before operating batteries, such as watches and rings.
- Do not place the battery module in a fire, water or other liquids.
- Do not use water to clean electrical components of the equipment.

## BATTERY EMERGENCY MEASURES

- Avoid contact with leaked liquids or gases in the case of battery leakage or abnormal odor. Do not approach the battery. Contact professionals immediately. Professionals must wear safety goggles, rubber gloves, gas masks, and protective clothing.
- Electrolyte is corrosive and can cause irritation and chemical burns. Should you come into direct contact with the battery electrolyte, do as follows:
  - Inhalation: Evacuate contaminated areas, get fresh air immediately, and seek immediate medical attention.
  - Eye contact: Immediately flush your eyes with water for at least 15 minutes, do not rub your eyes, and seek medical attention immediately.
  - Skin contact: Wash the affected areas immediately with soap and water and seek medical attention immediately.
  - Ingestion: Seek immediate medical attention.
- If the battery catches fire, extinguish the fire with sand, carbon dioxide, or dry powder fire extinguishers.
- Do not contact with high-voltage components during fire fighting to prevent the risk of electric shock.
- If any part of the batteries is submerged in water, do not touch the batteries to avoid electric shock.
- Do not use batteries that have been soaked in water. Contact a battery recycling company for disposal.
- If a battery pack is dropped or violently impacted during installation, internal damage may occur. Do not use such battery packs; otherwise, safety risks such as cell leakage and electric shock may arise. Contact the

professionals to transfer the battery to an open and safe place, or contact a recycling company for disposal.

## TRANSPORTATION REQUIREMENTS

- The batteries cannot be transported by rail or air.
- Comply with maritime transport & road transport rules.

## BASIC REQUIREMENTS

- Being dampened by rains, snows, or falling into water
- Falling or mechanical impact
- Being upside-down or tilted.

## INSTALLATION ENVIRONMENT REQUIREMENTS

1. The installation and use environment must meet relevant international, national, and local standards for lithium batteries, and are in accordance with the local laws and regulations.
2. Ensure that the battery is not accessible to children and away from daily working or living areas.
3. When installing the battery in a garage, keep it away from the drive way.
4. Install the battery in a dry and well-ventilated environment. Secure the battery on a solid and flat surface.
5. Install the battery in a sheltered place or install an awning over it to avoid direct sunlight or rain.
6. Install the battery in a clean environment that is free from sources of strong infrared radiation, organic solvents, and corrosive gases.
7. For areas prone to natural disasters such as floods, debris flows, earthquakes, and typhoons/hurricanes, take corresponding precautions for installation.
8. Keep the battery away from fire sources and heat sources. Do not place any flammable or explosive materials around the battery.
9. Keep the battery away from water sources such as taps, sewer pipes, and sprinklers to prevent water seepage.
10. Do not install the battery in a position where it is easy to touch as the temperature of the chassis and heat sink is high when the battery is running.
11. To prevent fire due to high temperature, ensure that the vents and the cooling system are not blocked when the battery is running.
12. Do not expose the battery to flammable or explosive gas or smoke. Do not perform any operation on the battery in such environments.
13. This product is designed for residential scenarios. Do not install the battery on a moving object, such as ship, train, or car.
14. In backup power scenarios, do not use the battery for the following situations:
  - Medical devices substantially important to human life
  - Control equipment such as trains and elevators, which may cause personal injury
  - Computer systems of social and public importance
  - Other devices similar to those described above
15. Do not install the battery outdoors in salt-affected areas because it may corrode. A salt-affected area refers to the region within 500 meters from the coast or prone to sea breeze.

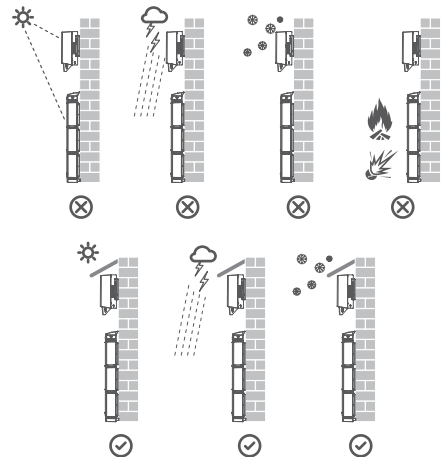

- The operation and service life of the battery depend on the operating temperature. Install the battery at a temperature equal to the ambient temperature or in a better environment.
- The operating temperature of the battery ranges from  $-20^{\circ}\text{C}$  to  $+50^{\circ}\text{C}$ . If the battery is installed in a cold environment, the built-in thermal control system starts to heat the battery to achieve better performance. The heating process consumes rechargeable power, which reduces the system energy efficiency for a short time in cold weather.
- If the battery is stored in a cold environment (for example,  $0^{\circ}\text{C}$ ) before installation, the battery needs some time ( $< 30$  mins) to heat up before it can be charged. You are advised to place the battery in a warm place before installation.
- When the ambient temperature of the battery is higher than  $+45^{\circ}\text{C}$  or lower than  $-10^{\circ}\text{C}$ , the battery charge and discharge power will be derated.

## EQUIPMENT AND PERSONNEL SAFETY REQUIREMENTS

### MOVING THE EQUIPMENT

1. When moving the equipment by hand, wear protective gloves to prevent injuries.
2. When moving the batteries, both hands should hold the handle at the top of the battery firmly, do not put your hands at the bottom of the battery when the batteries are being stacked and installed, otherwise, it may crush your hands.
3. Move the batteries with precaution as the battery modules are heavy. When two or more people are needed to assist in moving the batteries, ensure communication and coordination between personnels to prevent being crushed or sprained.

### USING TOOLS

1. Use wooden or fiberglass ladders when you need to perform live working at heights.
2. Before using a ladder, check that it is intact and confirm its load bearing capacity. Do not overload it.
3. Make sure the operator is regulated in the use of installation tools, such as ladders, electric paddles, drills, etc. Make sure the tool power cord is not tangled.
4. When installing, strictly prevent screws, nuts and spacers from falling inside the equipment and ensure that the tools (such as electric drill bit) do not fall into the gap between the installed equipment and the wall to prevent delaying the installation.

### DRILLING HOLES

1. Wear goggles and protective gloves when drilling holes.
2. When drilling holes, protect the equipment from shavings or dust. After drilling, clean up any shavings or dust that have accumulated at the installation site in a timely manner, otherwise, it may block the drilled hole.

## DISPOSAL

For information on the disposal of electrical and electronic equipment, please visit the following website:

<https://eu.ecoflow.com/pages/electronic-devices-disposal>

## Product Introduction

### FUNCTION

This battery system consists of a battery junction box, battery expansion modules and a battery base. It can store and release electric energy based on the requirements of the inverter management system. The input and output ports of the EF BD-5.1-S1 battery are high-voltage direct current (HVDC) ports.

- Battery charge: The junction box connects to the battery terminals (BAT+ and BAT-) of the inverter. Under the control of the inverter, the system charges the batteries and stores excessive PV energy in batteries.
- Battery discharge: When the PV energy is insufficient to supply power to the loads, the system controls the batteries to supply power to the loads. The battery energy is output to the loads through the inverter.

### BATTERY CAPACITY DESCRIPTION

The battery supports power and capacity expansion. Up to three junction boxes can be connected in parallel. One junction box supports a maximum of three battery expansion modules.

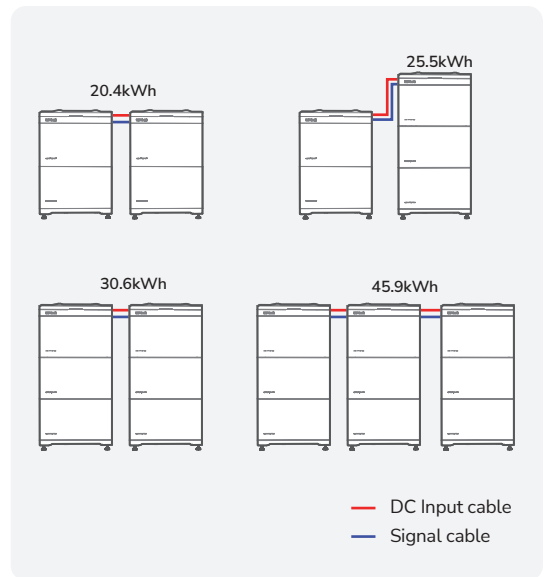
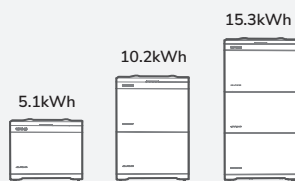

## NETWORKING APPLICATION

EcoFlow PowerOcean LFP Battery is a parallel connected high voltage battery system, compatible with our 3-phase hybrid inverter.

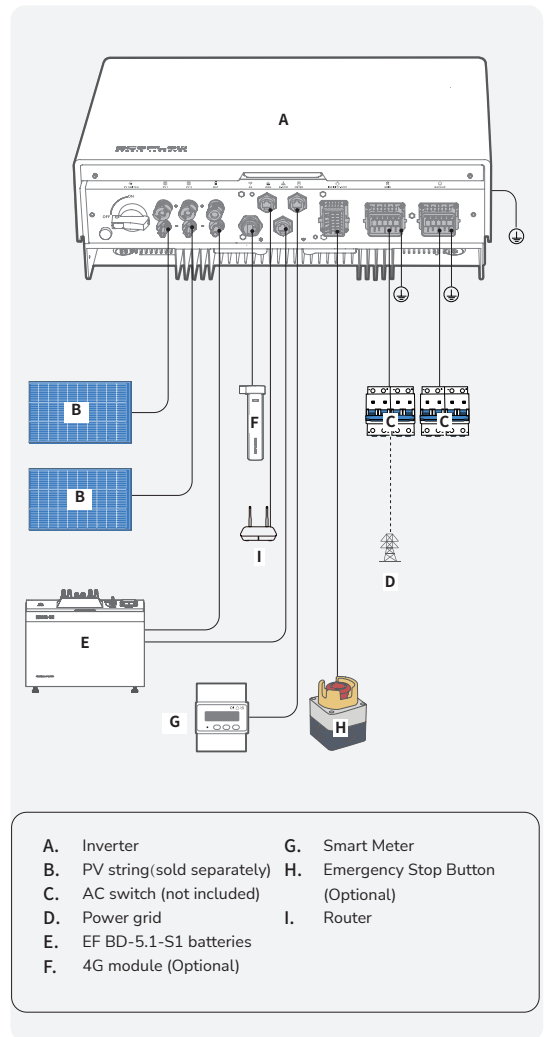

## APPEARANCE

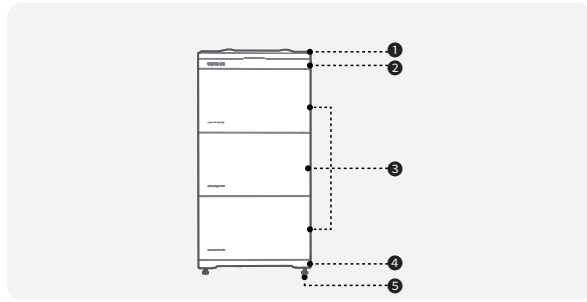

- 1 Trim cover
- 2 Battery junction box
- 3 Battery expansion module
- 4 Base
- 5 Adjustable feet

## EF BD-JC-S1

### BATTERY JUNCTION BOX

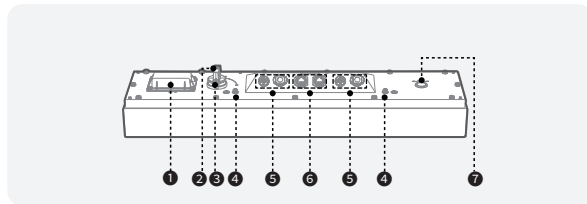

- 1 Fuse
- 2 Lock hole button: press and hold to reveal the lock hole and lock to prevent accidental startup.
- 3 BATTERY SWITCH: Controls only the battery module, no control over other power
- 4 Ground point
- 5 Battery terminal (BAT-/BAT+)
- 6 Communication port (COM2/COM1)
- 7 BATTERY ON/OFF button

## EF BD-5.1-S1

### BATTERY

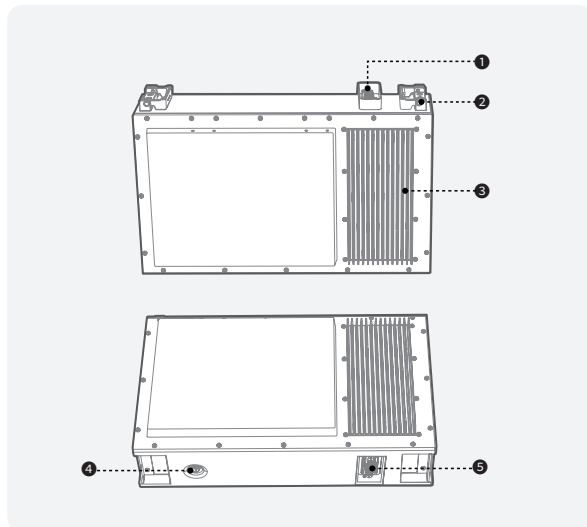

- 1 Click-on terminal
- 2 Handles
- 3 Radiator grille
- 4 Pressure release valve
- 5 Click-on terminal

## EF BD-B-S1

### BASE

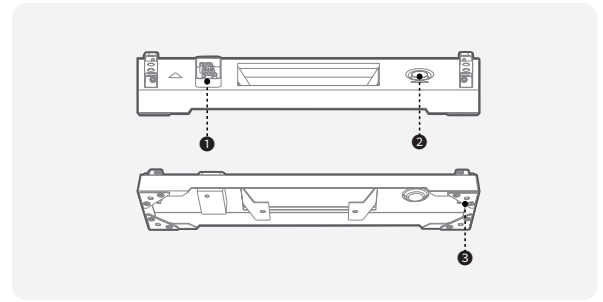

- 1 Click-on terminal
- 2 Level
- 3 Adjustable feet mounting holes

## LABEL DESCRIPTION

### ENCLOSURE LABELS

Icon	Name	Meaning
	Electric shock warning	Caution, risk of electric shock
	Delayed discharge	Danger to life due to high voltages in the inverter; observe a waiting time of 5 minutes. High voltages that can cause lethal electric shocks are present in the live components of the inverter. Prior to performing any work on the inverter, disconnect it from all voltage sources as described in this document.
	Burn warning	Do not touch a running equipment because the enclosure is hot when the equipment is running.
	Refer to documentation	Reminds operators to refer to the documents delivered with the equipment.
	Grounding	Indicates the position for connecting the protective earthing (PE) cable.
	Operation warning	Do not remove the AC/DC connector when the equipment is running.
	Symbol of a crossed-out trash can	WEEE designation Do not dispose of the product together with the household waste but in accordance with the disposal regulations for electronic waste applicable at the installation site.
	CE marking	The product complies with the requirements of the applicable EU directives.



The labels are for reference only.

## FEATURES

### MULTI-SCENARIO AND MULTI-WORKING MODE

- Supports multiple working modes such as grid-tied, power backup scenario, self-consumption mode.
- Allows users to query the total discharge capacity in the product life cycle in real time.

### INTELLIGENT AND SIMPLE OPERATION

Works with the inverter, supports plug-and-play, and integrates the mobile phone app.

### EASY INSTALLATION AND REPLACEMENT

- Standard battery DC terminals are used for system connection.
- Modular design is adopted for batteries, which are stacked and connected without external cables.
- Modular design is adopted for battery junction box, which is designed for easy connection to the inverter.
- Sleek Design saves installation space.

### FLEXIBLE SCALABILITY

- The battery system supports power expansion, battery capacity expansion, and hybrid use of old and new batteries.
- The battery system supports isolation of failed battery modules to ensure that the energy storage system can still operate normally.

### INTELLIGENT OPERATION AND MAINTENANCE

- The factory defaults meet the requirements of target markets and the battery can be started by pressing only one button and supports black startup.
- The LED indicator shows the status. You can also use the EcoFlow app to perform local and remote operations and manage the battery anytime and anywhere.

### SAFE AND EFFICIENT

- BMS module is embedded within every battery pack, achieving a compact design with no extra power module on top of batteries.
- Active aerosol fire protection module in every battery pack to secure maximum safety.

## System Modes

### SELF-POWERED MODE

- This mode applies to areas where the electricity price is high, or areas where the feed-in tariff subsidy is low or unavailable.
- Excess PV energy is stored in batteries. When PV power is insufficient or no PV power is generated at night, batteries discharge to supply power to the loads, improving the self-consumption rate of the PV system and the self-sufficiency rate of residential energy, and reducing electricity costs.
- In this mode, by default, the charge cutoff capacity is 100% and the discharge cutoff capacity is 5% for EcoFlow EF BD-5.1-S1 LFP batteries.

## Checking before the Installation

### CHECKING OUTER PACKAGING

Before unpacking the EF BD-5.1-S1, check the outer packing for damage, such as holes and cracks, and check the EF BD-5.1-S1 model. If any damage is found, do not unpack the package and contact your dealer as soon as possible.

### CHECKING DELIVERABLES

After unpacking the EF BD-5.1-S1, check that the deliverables are intact and complete. If any item is missing or damaged, contact your supplier.



For details about the number of accessories delivered with the EF BD-5.1-S1, see **What's In The Box** in the Installation Guide.

## System Installation

For System Installation, please refer to Installation Guide delivered with the equipment.

## Electrical Connection

For Electrical Connection, please refer to Installation Guide delivered with the equipment.

## System Commissioning

For System Commissioning, please refer to Installation Guide delivered with the equipment.

## SYSTEM POWER-ON

### PROCEDURE (ON-GRID AND PV MODULE CONFIGURED)

1. Set the BATTERY SWITCH on top of the Junction Box to ON position.
2. Turn on the AC switch between the inverter and the power grid.
3. Set the PV SWITCH at the bottom of the inverter to ON position.
4. Observe the LED to check the inverter operating status.

### PROCEDURE (OFF-GRID AND NO PV MODULE CONFIGURED)

1. Set the BATTERY SWITCH on top of the Junction Box to ON position.
2. Turn on the AC switch between the inverter and the power grid.
3. Set the PV SWITCH at the bottom of the inverter to ON position.
4. After commissioning, press and hold for three seconds the BATTERY ON/OFF button on top of the battery junction box.
5. Observe the LED to check the inverter operating status.

### LED INDICATOR: FOUR BARS

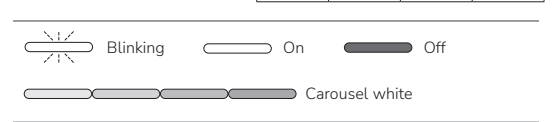

Charge Status	Description
	0-25%
	25-50%
	50-75%
	75-99%
	100%
Discharge Status	Description
	<5%
	5-25%
	25-50%
	50-75%
	75-100%
Firmware Upgrading Status	Description
	Firmware Upgrading is in progress
Faulty Status	Description
	Electrical connection is faulty
	Communication is faulty
	Battery is faulty
	Battery junction box is faulty

# System Maintenance

## WARNING

- Only qualified professionals are allowed to install, operate, and maintain the equipment.
- Before maintaining the equipment, power it off and follow the instructions on the delayed discharge label to ensure that the equipment is powered off.
- (Optional) After setting the BATTERY SWITCH on the top of the battery junction box to OFF position, it should be locked to prevent accidental startup.
- Before moving or reconnecting the equipment, disconnect the mains and batteries and wait for five minutes until the equipment powers off. Before maintaining the equipment, check that no dangerous voltages remain in the DC terminals to be maintained by using a multimeter.
- Place temporary warning signs or erect fences to prevent unauthorized access to the maintenance site.
- If the equipment is faulty, contact your dealer.
- The equipment can be powered on only after all faults are rectified. Failing to do so may escalate faults or damage the equipment.
- Maintenance personnel must be trained to operate and maintain the equipment safely and correctly, take comprehensive precautionary measures, and be equipped with protective instruments.
- When replacing batteries, replace them with batteries or battery strings of the same type.
- Take out all tools and parts from the equipment after maintenance is complete.
- When not in use for extended periods, store and recharge batteries according to this document.

## SYSTEM POWER-OFF

### PROCEDURE

1. Send a shutdown command on the App.
2. Turn off the AC switch between the inverter and the power grid.
3. Set the PV SWITCH at the bottom of the inverter to OFF position.
4. (Optional) Press and hold the button on the PV SWITCH to reveal the lock hole and lock it up to prevent accidental startup. The lock is prepared by the customer.
5. Set the BATTERY SWITCH on top of the Junction Box to OFF position.
6. (Optional) Press and hold the button on the BATTERY SWITCH to reveal the lock hole and lock it up to prevent accidental startup. The lock is prepared by the customer.
7. Press and hold the BATTERY ON/OFF button of the junction box for 10 seconds, until the indicator is off.

## ROUTINE MAINTENANCE

To ensure that the battery can operate properly for a long term, you are advised to perform routine maintenance on it as described in this chapter.

## WARNING

- Power off the system and follow the instructions on the delayed discharge label to ensure that the equipment is powered off.
- Wear proper PPE before any operations.

Check Item	Check Method	Maintenance Interval
System cleanliness	Check periodically that the heat sinks are free from obstacles and dust. If there is any stain/dirt, use a dry, soft cloth to wipe it off and prohibit the use of stain removing powder, any liquid, coarse brush, abrasives or hard objects to clean the equipment. Ensure equipment ventilation and heat dissipation.	Once every 6 months
System running status	Check that the equipment is not damaged or deformed. Check that the equipment operates with no abnormal sound. Check that all equipment parameters are correctly set during operation.	Once every 6 months
Electrical connection	Check that cables are secured. Check that cables are intact.	Once every 6 months
Grounding reliability	Check that ground cables are securely connected.	Once every 6 months
Seal ability	Check that unused terminals, ports, waterproof covers are locked as delivered.	Once every 6 months

## BATTERY STORAGE AND RECHARGE

### BATTERY STORAGE REQUIREMENTS

- Place batteries according to the signs on the packing case during storage. Do not put batteries upside down or sidelong.
- Stack battery packing cases by complying with the stacking requirements on the external package.
- Handle batteries with caution to avoid damage.
- The storage environment requirements are as follows:
  - Ambient temperature: -10~55°C; recommended storage temperature: 20~30°C
  - Relative humidity: 0% to 100%
  - Place batteries in a dry and clean place with good ventilation.
  - Place batteries in a place that is away from corrosive organic solvents and gases.
  - Keep batteries away from direct sunlight, heat source, fire source and water source.
- The batteries in storage must be disconnected from external devices. The indicators on the battery junction box should be off.
- If the battery is not used for a long period of time, it is recommended to be stored intact in a semi-charged state (60% SOC). The battery is recommended to be discharged to 30% and then recharged to 60% every three months.
- If the power level of the battery is lower than 1% after use, recharge it to 60% before storage. If the battery has been idle for a long time when the power is seriously insufficient, it will cause irreversible damage to the cells and shorten the service life of the battery.
- If the battery has been idle for a long time and the power level is severely low, it will enter a deep sleep protection mode. In such a case, recharge the battery before using it again.
- When solar irradiance declines and the PV string current drops to below 0.5 A, and the battery SOC is excessively low, the system will automatically switch to Grid power.

## REPLACING A FUSE

The Battery junction box has a built-in DC 1500 V/20A replaceable fuse. Under normal operating conditions, there is no risk of fuse blowing. When an external short circuit occurs and the battery management system is not protected in time, the fuse will blow immediately to protect the battery. When a short circuit occurs and the battery cannot be charged or discharged, the fuse must be replaced. Replacement procedure is as follows:

## NOTICE

- Please use fuses with local certification standards

### PROCEDURE

1. Power off the system. For details, see chapter: System Power-Off.

## WARNING

- After the system is powered off, the remaining electricity and heat still exist in the chassis, which may cause electric shocks or burns. Therefore, you need to wear protective gloves and perform operations 5 minutes after the system is powered off.
- Only qualified professionals are allowed to replace a fuse.
- 2. Loosen the screws on the fuse shell.
- 3. Lift the fuse box opening, remove the fuse, insert a new fuse of the same specification as the old one into the slot, and close the fuse box.
- 4. Lock the fuse shell with screws.

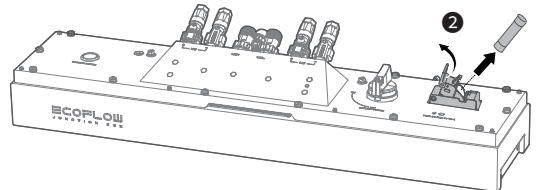
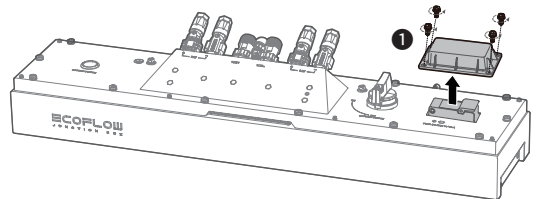



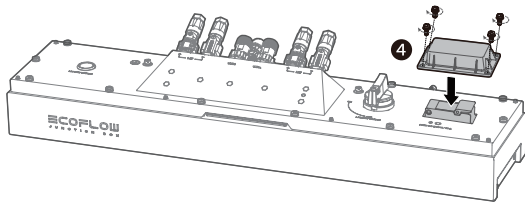
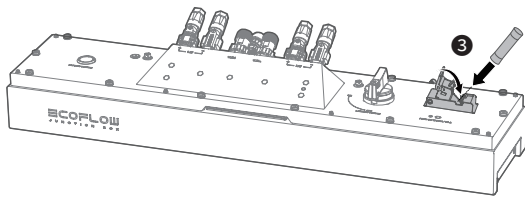

#### FUSE SPECIFICATION

Fuse type	Fast blow fuse
Rated voltage	1500 V DC
Rated current	20 A
Breaking capacity	10 kA@1500 Vd.c.
Nominal fusing heat I <sup>2</sup> T	400-2200
Cold resistance value	0.005~0.0075Ω
Dimensions	14.2*5 mm
Fuse model	A842200b00

## Used Batteries Disposal



- When conditions permit, be sure to completely discharge the battery before placing the battery in the designated battery recycling bin. This product contains batteries. Batteries are dangerous chemicals and should not be disposed of in ordinary trash bins. For details, follow the local battery recycling and disposal laws and regulations.
- If the battery cannot be completely discharged due to battery failure, do not dispose of the battery directly in the battery recycling bin, and contact a professional battery recycling company for further processing.
- If the battery cannot start after being discharged, dispose of it according to local laws and regulations on battery recycling and disposal.
- Hereby, our products have met the regulations of BattG in Germany.

# Technical Parameters

Number of battery packs		EF BD-JC-S1 x 1 EF BD-5.1-S1 x 1 EF BD-B-S1 x 1	EF BD-JC-S1 x 1 EF BD-5.1-S1 x 2 EF BD-B-S1 x 1	EF BD-JC-S1 x 1 EF BD-5.1-S1 x 3 EF BD-B-S1 x 1
<b>Performance</b>	Battery module capacity	5.1kWh	10.2kWh	15.3kWh
	Max. output power	3.3kW	6.6kW	9.9kW
	Max. input power	2.5kW	5kW	7.5kW
	Nominal voltage	800V		
	Operating voltage range	720~960V		
	Battery cell type	LFP		
<b>Compliance</b>	Certificates	CE/CB/TUV MARK		
	Safety standard	IEC/EN62619, IEC/EN62040-1, IEC/EN62477-1, ISO13849		
	Delivery standard	UN38.3		
	EMC	EN 61000-6-1, EN 61000-6-3		
<b>General specification</b>	Dimension (without adjustable feet)	680*612*183mm	680*1009*183mm	680*1406*183mm
	Power module weight	65.6kg	120.9kg	176.2kg
	Installation	Floor stand		
	Operating temperature	-20°C~50°C		
	Max. operating altitude	3000m		
	Cooling method	Natural convection		
	Noise level	≤35dB		
	Relative humidity	0~100% RH		
	Protection level	IP65		
Protective class	I			

